

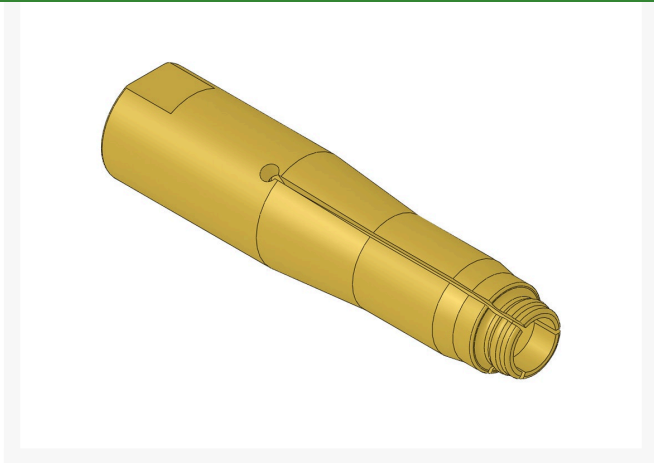

Expanding Puller Tube Only - Fits R235 R236



Details

R&R Products developed a special line of tools to remove tapered bearing races from rollers, gear boxes and the outer ball bearing races left inside roller ends, in case of a catastrophic bearing failure. The R&R Puller contains a mandrel and spreader which secures behind the tapered bearing race or to the inside ball bearing groove. The tube assembly, which contains its own tapered bearing pulling system, is then placed over the mandrel and spreader to easily remove the outer race. Mandrels and spreaders are manufactured by R&R Products from high carbon chromium vanadium steel and heat treated for maximum strength.

Specifications

Manufacturer

R&R Products

Gritmaster

309 Percy Osborn Road Morningside, 4001
0313035785

<https://gritmaster.rrproducts.com/>