

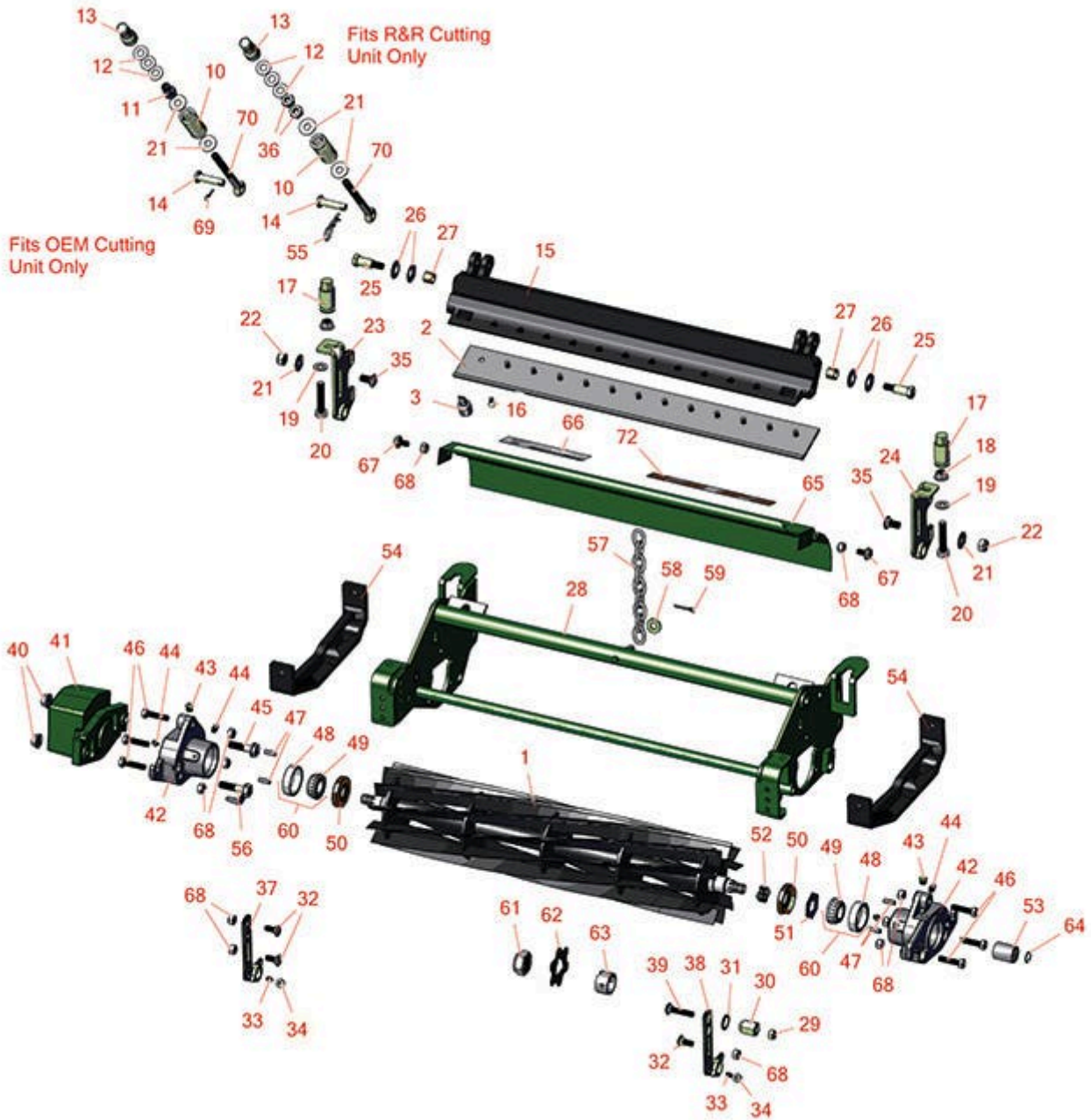

Replaces John Deere 3215B Reel Mower

Parts

Medium Cutting Unit
Reel & Bedknife



All original equipment manufacturers names and part numbers are used for identification purposes only, and we are in no way implying that our products are original equipment parts. Prices subject to change without notice.



Replaces John Deere 3215B Reel Mower

Parts

Medium Cutting Unit
Reel & Bedknife



Item No	R&R Part No.	OEM Part No.	Description	Qty Req	Order Quantity
---------	--------------	--------------	-------------	---------	----------------

R&R Reels, Lifetime Guaranteed

1	RAET11237	AET11237, AMT2883	Reel - 7 Blade Heavy Duty - External Spline	1	
1	R101274	AMT2885, AMT538	Reel - 11 Blade - External Spline	1	

R&R Bedknives, Lifetime Guaranteed

2	RET17767	ET17767, UC23562	Bedknife - High Cut 5/16	1	
2	RET17532	ET11066, ET17532	Bedknife - Fairway .189 Min	1	
2	RET17533	ET14402, ET17533, ET17767, MT4869, MT7351, UC18873	Bedknife - 22in Standard- .126 Min. HOC	1	
2	RET17534	ET17534	Bedknife - 22in Tournament- .098 Min HOC	1	
2	RMT7351	ET17489, MT7351, UC19154, UC28163	Bedknife - 22in Lo-Cut .079 Min. HOC	1	

R&R Razor Tool Steel Bedknives, Lifetime Guaranteed

2	R130116	MT4846, UC18877	Bedknife - Razor Tool Steel - 22 Tournament Cut	1	
2	R130130		Bedknife - Razor Tool Steel - 22 High Cut	1	

Service Tools

3	R101278T		Bedknife Screw Driver Tool	0	
---	-----------------	--	----------------------------	---	--

Tech Note: Easily install and remove bed knife screws with the help of a ratchet. Tool manufactured with hardened alloy steel.:

All original equipment manufacturers names and part numbers are used for identification purposes only, and we are in no way implying that our products are original equipment parts. Prices subject to change without notice.



Replaces John Deere 3215B Reel Mower

Parts

Medium Cutting Unit
Reel & Bedknife



Item No	R&R Part No.	OEM Part No.	Description	Qty Req	Order Quantity
---------	--------------	--------------	-------------	---------	----------------

Other Parts Available

10	RET11070	ET11070	Spring - Bed Bar	2	
11	RMT6486	MT6486	Nut - Bed Bar Adjusting	2	
12	RET16679	ET16679	Washer - Spring	6	
13	RMT6990	MT6990	Nut - Adjusting	2	
14	R45M7060	45M7060	Pin	2	
15	RMT2694	MT2694	Bed Bar	1	
16	R101278	21M7194	Screw - Bedknife	13	
17	RMT6483	MT6483	Nut - Adjusting Rear Roller	2	
18	R14M7296	14M7296	Nut - 10mm x 1.5 Flanged	2	
19	R24M7096	24M7096	Washer	2	
20	R19M7383	19M7383	Bolt - Rear Roller Adj 55 mm Long	2	
20	R19M7385	19M7385	Bolt - Rear Roller Adj 70mm Long	2	
21	RP250-52	T105740	Washer - 3/8 USS Flat Zinc	2	
22	R14M7517	14M7517	Locknut - 10mm x 1.5 ESNA	2	
23	RAMT5112	AMT5112	Bracket - Roller RH Rear	1	
24	RAMT5113	AMT5113	Bracket - Roller LH Rear	1	
25	RMT3016	MT3016	Bolt - Bed Bar	2	
26	RN168012	N168012	Washer - Spring	4	
27	RB30499	B30499	Bushing - Bed Bar	2	
28	R130121	AMT1415	Frame - Cutting Unit	1	
29	R14M7166	14M7166	Locknut - 8mm x 1.25 ESNA	1	

All original equipment manufacturers names and part numbers are used for identification purposes only, and we are in no way implying that our products are original equipment parts. Prices subject to change without notice.



Replaces John Deere 3215B Reel Mower

Parts

Medium Cutting Unit
Reel & Bedknife



Item No	R&R Part No.	OEM Part No.	Description	Qty Req	Order Quantity
30	RMT3881	MT3881	Nut - Eccentric Front Roller Bkt	1	
31	R12M7052	12M7052	Washer - Rib Lock	1	
32	R03M7184	03M7184	Bolt - Carriage M8	3	
33	R22H1004	19H3003	Screw - Set 1/4-28 x 1/2	2	
34	R3219-1	14H860	Nut - 1/4-28	2	
35	R03M7191	03M7191	Bolt - Carriage M10 x 25	2	
36	R130123	130123	Nut - Hex 10mm x 1.0	4	
37	RMT3015	MT3015	Bracket - RH - Extended	1	
37	RMT7259	MT7259	Bracket - RH	1	
38	RMT3072	MT3072	Bracket - LH - Extended	1	
38	RMT7260	MT7260	Bracket - LH	1	
39	R03M7188	03M7188	Bolt - Carriage M8 x 40	1	
40	RH135891	H135891	Locknut - 10mm x 1.5 Flanged 10.9	2	
<i>Tech Note: High Strength:</i>					
41	RMT6476	MT6476	Counterweight	1	
42	RMT7294	MT2647, MT7294	Housing - Reel	2	
43	R170714	E14814	Fitting - Pressure Relief	2	
44	R302-5	JD7797, JD7842, JD7844	Fitting - Grease	4	
45	R19M7804	19M7804	Bolt - Flanged Hex M10-1.5 x 40	2	
46	R19M8008	19M8008	Bolt - Hex HD M8-1.25 x 35	6	

All original equipment manufacturers names and part numbers are used for identification purposes only, and we are in no way implying that our products are original equipment parts. Prices subject to change without notice.



Replaces John Deere 3215B Reel Mower Parts

Medium Cutting Unit
Reel & Bedknife



Item No	R&R Part No.	OEM Part No.	Description	Qty Req	Order Quantity
47	RR30587	30587, R30587	Pin - Dowell 1/4 Dia. x .75	4	
48	R254-79	JD8226	Cup - Bearing	2	
<i>Tech Note: Use R254-79M installation mandrel to properly install race.:</i>					
49	R254-78	JD8188	Tapered Bearing Cone	2	
50	RET14566	ET14566	Seal - Reel	2	
51	RET16704	ET16704	Retainer	1	
52	RET14592	ET14592	Spring - Reel Bearing	1	
53	RTCA12581	TCA12581	Coupling - Reel 11 Tooth	1	
54	RMT2527	MT2527	Shoe - Skid	2	
55	R130122		Clip - Hitch Pin	1	
56	RAMT2261	AMT2261	Kit - Bolt w/Clip	2	
57	RAMT1479	AMT1479	Chain - Link	1	
58	R24H1682	24H1682	Washer - 13/32 x 7/8 x 1/8	1	
59	R460028	11M7059, 460028	Pin - Cotter 1/8 x 1	1	
60	R500534		Bearing - with Cup	2	
61	RN198341	N198341	Nut - Nyloc 7/8-14	1	
62	RMT2624	MT2624	Knife - Greens Conditioner	38	
63	RET14917	ET14917	Spacer	1	
64	RMT2745	MT2745	Snap Ring	1	
65	RAMT2495	AMT2495, AMT554	Shield - Grass	1	

All original equipment manufacturers names and part numbers are used for identification purposes only, and we are in no way implying that our products are original equipment parts. Prices subject to change without notice.



Replaces John Deere 3215B Reel Mower Parts

*Medium Cutting Unit
Reel & Bedknife*



Item No	R&R Part No.	OEM Part No.	Description	Qty Req	Order Quantity
66	R67-7960		Decal - Warning	2	
67	R19M7865	19M7865	Bolt - Hex Washer M8 x 16	2	
68	RH137328	H137328	Locknut	12	
69	R11M7012	11M7012	Pin - Cotter 1/8 x 5/8	2	
70	RMT3074	MT3074	Eyebolt - Bed Bar	2	
72	RMT6517	MT6517	Label - Warning	1	

All original equipment manufacturers names and part numbers are used for identification purposes only, and we are in no way implying that our products are original equipment parts. Prices subject to change without notice.